

RoHS

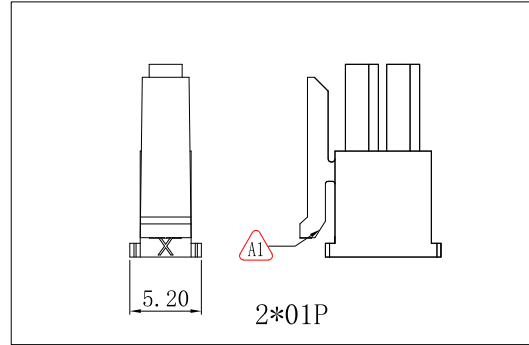
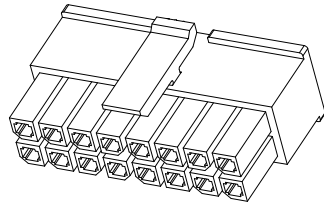
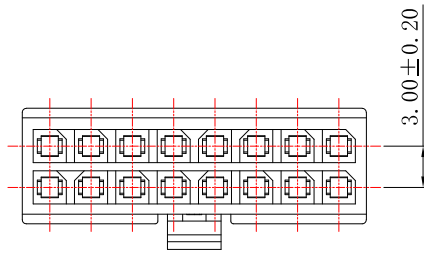

- SPECIFICATIONS :
- Voltage Rating: 250V AC / DC
 - Current Rating: 5A AC / DC
 - Withstanding Voltage: 1000V AC/minute
 - Temperature Range: -40℃~+105℃
 - Insulation Resistance: 1000MΩ Min.
 - Contact Resistance: 10mΩ Max.
 - Suitable JVT3025T series Terminal
 - Suitable JVT3026W series Wafer

■ Material:
Material: PA66 UL 94V-0
Color:natural color/Black

- Packing specifications:
2*01~2*03P 2,000 pcs/bag
2*04P above 1,000 pcs/bag
- *is the key control size

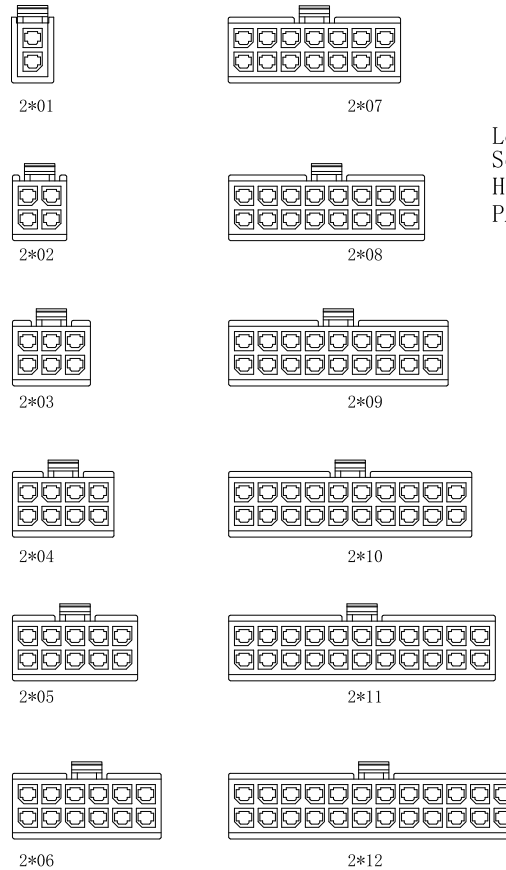
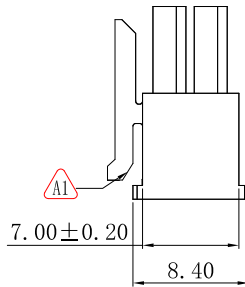
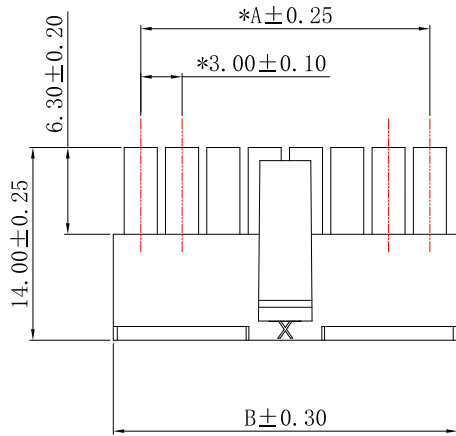

JVT3025HNO-2*XXXX

Logo—
Series NO.—
Housing—
PA66 UL94V-0—

Blank-Natural color
BK-Black
Single row Pin NO.

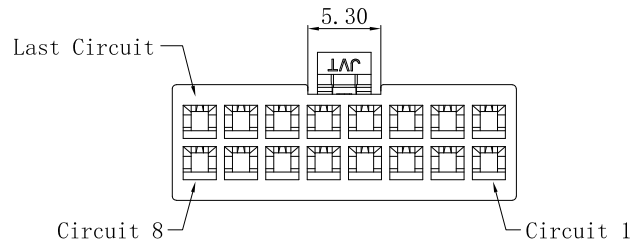

POLES	A	B
2*01	5.20	7.00
2*02	3.00	7.00
2*03	6.00	10.00
2*04	9.00	13.00
2*05	12.00	16.00
2*06	15.00	19.00
2*07	18.00	22.00
2*08	21.00	25.00
2*09	24.00	28.00
2*10	27.00	31.00
2*11	30.00	34.00
2*12	33.00	37.00

				GENERAL TOLERANCE				JVT 乔业连接器 JVT CONNECTORS				Approved by		Check		Design		Standard					
				0	±0.35					LI		CLYDE		LU		P/N		3.0mm HSG "JVT"					
A1				.0	±0.30					Version		Date		Date		Map title		031		Version		A1	
Version				.00	±0.20					Content of change		Date		Date		Date		031		Version		A1	
				.000	±0.10					Date		Date		Date		Date		Date					