

10G SFP+ DWDM 80KM Transceivers

PRODUCT FEATURES

- Up to 11.3Gbps Data Links
- Up to 80km transmission on SMF
- DWDM EML Laser and APD receiver
- Metal enclosure, for lower EMI
- 2-wire interface with integrated Digital Diagnostic monitoring
- Hot-pluggable SFP+ footprint
- Specifications compliant with SFF 8472
- Compliant with SFP+ MSA with LC connector
- Single 3.3V power supply
- Case operating temperature range:0°C to 70°C
- Power dissipation < 1.5W

APPLICATIONS

- 10G Ethernet
- 10G SONET/SDH, OTU2/2e and 10G FC

STANDARD

- Compliant to SFF-8431
- RoHS Compliant.

DESCRIPTION

The SFP+ DWDM 80KM transceivers include an APD diode and temperature stabilized DFB-EML transmitter. Digital diagnostic functions are available via an I2C. This module is designed for single mode fiber and operates at a nominal wavelength of 100GHz ITU Grid, C Band DWDM wavelength.

PRODUCT SELECTION

C-band λ_c Wavelength Guide Pin Descriptions

Channel	Wavelength (nm)	Frequency (THZ)	Channel	Wavelength (nm)	Frequency (THZ)
C17	1563.86	191.7	C39	1546.12	193.9
C18	1563.05	191.8	C40	1545.32	194
C19	1562.23	191.9	C41	1544.53	194.1
C20	1561.42	192	C42	1543.73	194.2
C21	1560.61	192.1	C43	1542.94	194.3
C22	1559.79	192.2	C44	1542.14	194.4
C23	1558.98	192.3	C45	1541.35	194.5
C24	1558.17	192.4	C46	1540.56	194.6
C25	1557.36	192.5	C47	1539.77	194.7
C26	1556.55	192.6	C48	1538.98	194.8
C27	1555.75	192.7	C49	1538.19	194.9
C28	1554.94	192.8	C50	1537.4	195
C29	1554.13	192.9	C51	1536.61	195.1
C30	1553.33	193	C52	1535.82	195.2
C31	1552.52	193.1	C53	1535.04	195.3
C32	1551.72	193.2	C54	1534.25	195.4
C33	1550.92	193.3	C55	1533.47	195.5
C34	1550.12	193.4	C56	1532.68	195.6
C35	1549.32	193.5	C57	1531.9	195.7
C36	1548.51	193.6	C58	1531.12	195.8
C37	1547.72	193.7	C59	1530.33	195.9
C38	1546.92	193.8	C60	1529.55	196
Non-ITU	Peak wavelength between 1528.77nm-1563.86		C61	1528.77	196.1

I. Absolute Maximum Ratings

Parameter	Symbol	Min.	Typ.	Max.	Unit	Note
Storage Temperature	Ts	-40	-	85	°C	
Relative Humidity	RH	5	-	95	%	
Power Supply Voltage	VCC	-0.3	-	4	V	
Signal Input Voltage		Vcc-0.3	-	Vcc+0.3	V	

II. Recommended Operating Conditions

Parameter	Symbol	Min.	Typ.	Max.	Unit	Note	
Case Operating Temperature	Tcase	0	-	70	°C	Without air flow	
Power Supply Voltage	VCC	3.14	3.3	3.47	V		
Power Supply Current	ICC	-		450	mA		
Data Rate	BR		10.3125	11.3	Gbps		
Transmission Distance	TD		-	80	km		
Coupled fiber		Single mode fiber					9/125um SMF

III. Optical Characteristics

Parameter	Symbol	Min	Typ	Max	Unit	NOTE
Transmitter						
Average Optical Power	Pout	-1		4	dBm	1
Optical Wavelength	λ_c	$\lambda_c-0.1$		$\lambda_c+0.1$	nm	
Center Wavelength Spacing			100		GHz	2
Optical Extinction Ratio	ER	6.0			dB	
Transmitter and Dispersion Penalty	TDP			3.0	dB	
Side mode Suppression ratio	SMSR	30			dB	
Average Launch Power	Poff			-30	dBm	
Output Eye Mask	Compliant with IEEE 802.3ae					
Receiver						
Rx Sensitivity	RSSENS			-23	dBm	3

Input Saturation Power (Overload)	Psat	-6			dBm	
Wavelength Range	λ_c	1480		1580	nm	
LOS De-Assert	LOSD			-26	dBm	
LOS Assert	LOSA	-35			dBm	
LOS Hysteresis		0.5			dB	

Notes:

1. Output power is power coupled into a 9/125 mm single-mode fiber.
2. Corresponds to approximately 0.8 nm.
3. Measured with a PRBS $2^{31}-1$ test pattern, @10.325Gb/s, BER< 10^{-12} .

IV. Electrical Characteristics

Parameter	Symbol	Min	Typ	Max	Unit	NOTE
Supply Voltage	Vcc	3.14	3.3	3.46	V	
Supply Current	Icc			450	mA	
Transmitter						
Input differential impedance	ohm		100		Ω	1
Differential data input swing	Vin,pp	120		820	mV	
Transmit Disable Voltage	VD	Vcc-1.3		Vcc	V	
Transmit Enable Voltage	VEN	Vee		Vee+0.8	V	2
TX_FAULT Voltage-High		Vcc-1.3		Vcc	V	
TX_FAULT Voltage-Low		Vee		Vee+0.8	V	
Receiver						
Differential data output swing	Vout,pp	350		850	mV	3
LOS De-assert		Vcc-1.3		VccHOST	V	4
LOS Assert		Vee		Vee+0.8	V	4

Notes:

1. Connected directly to TX data input pins. AC coupled thereafter.
2. Or open circuit.
3. Into 100 ohms differential termination.
4. Loss Of Signal is LVTTL. Logic 0 indicates normal operation; logic 1 indicates no signal detected.

V. Pin Descriptions

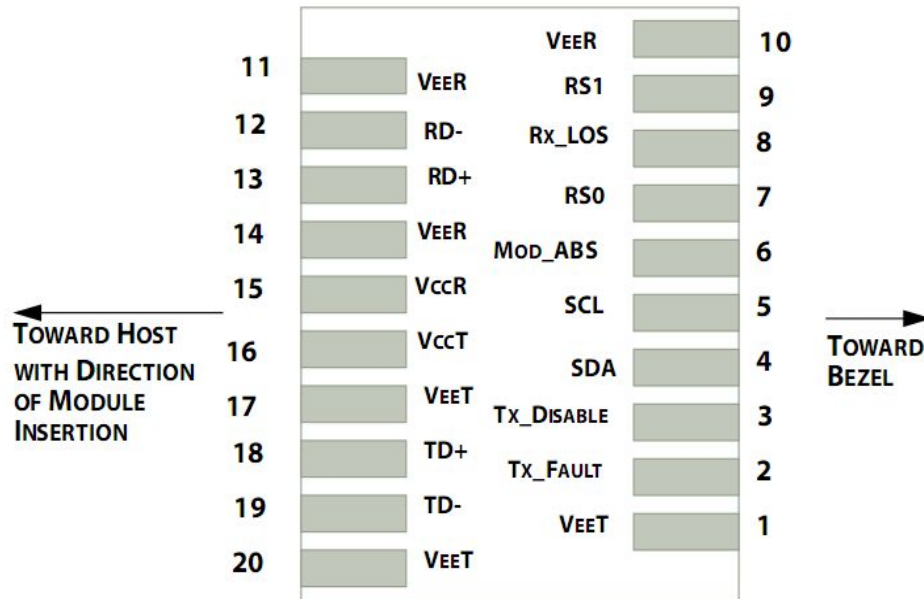

Pin out of Connector Block on Host Board

Pin	Symbol	Name/Description	NOTE
1	V _{EET}	Transmitter Ground (Common with Receiver Ground)	1
2	T _{FAULT}	Transmitter Fault.	2
3	T _{DIS}	Transmitter Disable. Laser output disabled on high or open.	3
4	SDA	2-wire Serial Interface Data Line	4
5	SCL	2-wire Serial Interface Clock Line	4
6	MOD_ABS	Module Absent. Grounded within the module	4
7	RS0	Rate Select 0	5
8	LOS	Loss of Signal indication. Logic 0 indicates normal operation.	6
9	RS1	No connection required	1
10	V _{EER}	Receiver Ground (Common with Transmitter Ground)	1
11	V _{EER}	Receiver Ground (Common with Transmitter Ground)	1
12	RD-	Receiver Inverted DATA out. AC Coupled	
13	RD+	Receiver Non-inverted DATA out. AC Coupled	
14	V _{EER}	Receiver Ground (Common with Transmitter Ground)	1
15	V _{CCR}	Receiver Power Supply	
16	V _{CCT}	Transmitter Power Supply	
17	V _{EET}	Transmitter Ground (Common with Receiver Ground)	1

18	TD+	Transmitter Non-Inverted DATA in. AC Coupled.	
19	TD-	Transmitter Inverted DATA in. AC Coupled.	
20	V _{EET}	Transmitter Ground (Common with Receiver Ground)	1

Notes:

1. Circuit ground is internally isolated from chassis ground.
2. T_{FAULT} is an open collector/drain output, which should be pulled up with a 4.7k – 10k Ohms resistor on the host board if intended for use. Pull up voltage should be between 2.0V to Vcc + 0.3V. A high output indicates a transmitter fault caused by either the TX bias current or the TX output power exceeding the preset alarm thresholds. A low output indicates normal operation. In the low state, the output is pulled to <0.8V.
3. Laser output disabled on T_{DIS} >2.0V or open, enabled on T_{DIS} <0.8V.
4. Should be pulled up with 4.7kΩ- 10kΩ host board to a voltage between 2.0V and 3.6V. MOD_ABS pulls line low to indicate module is plugged in.
5. Internally pulled down per SFF-8431 Rev 4.1.
6. LOS is open collector output. It should be pulled up with 4.7kΩ – 10kΩ on host board to a voltage between 2.0V and 3.6V. Logic 0 indicates normal operation; logic 1 indicates loss of signal.

VI. Digital Diagnostic Functions

The SFP+ DWDM 80KM transceivers support the 2-wire serial communication protocol as defined in the SFP+ MSA. The standard SFP serial ID provides access to identification information that describes the transceiver’s capabilities, standard interfaces, manufacturer, and other information.

Additionally, the SFP+ transceivers provide a unique enhanced digital diagnostic monitoring interface, which allows real-time access to device operating parameters such as transceiver temperature, laser bias current, transmitted optical power, received optical power and transceiver supply voltage. It also defines a sophisticated system of alarm and warning flags, which alerts end-users when particular operating parameters are outside of a factory set normal range.

The SFP+ MSA defines a 256-byte memory map in EEPROM that is accessible over a 2-wire serial interface at the 8 bit address 1010000X (A0h). The digital diagnostic monitoring interface makes use of the 8 bit address 1010001X (A2h), so the originally defined serial ID memory map remains unchanged.

The operating and diagnostics information is monitored and reported by a Digital Diagnostics Transceiver Controller (DDTC) inside the transceiver, which is accessed through a 2-wire serial interface. When the serial protocol is activated, the serial clock signal (SCL, Mod Def 1) is generated by the host. The positive edge clocks data into the SFP transceiver into those segments of the E2PROM that are not write-protected. The negative edge clocks data from the SFP transceiver. The serial data signal (SDA, Mod Def 2) is bi-directional for serial data transfer. The host uses SDA in conjunction with SCL to mark the start and end of serial protocol activation. The memories are organized as a series of 8-bit data words that can be addressed individually or sequentially.

VII. Host - Transceiver Interface Block Diagram

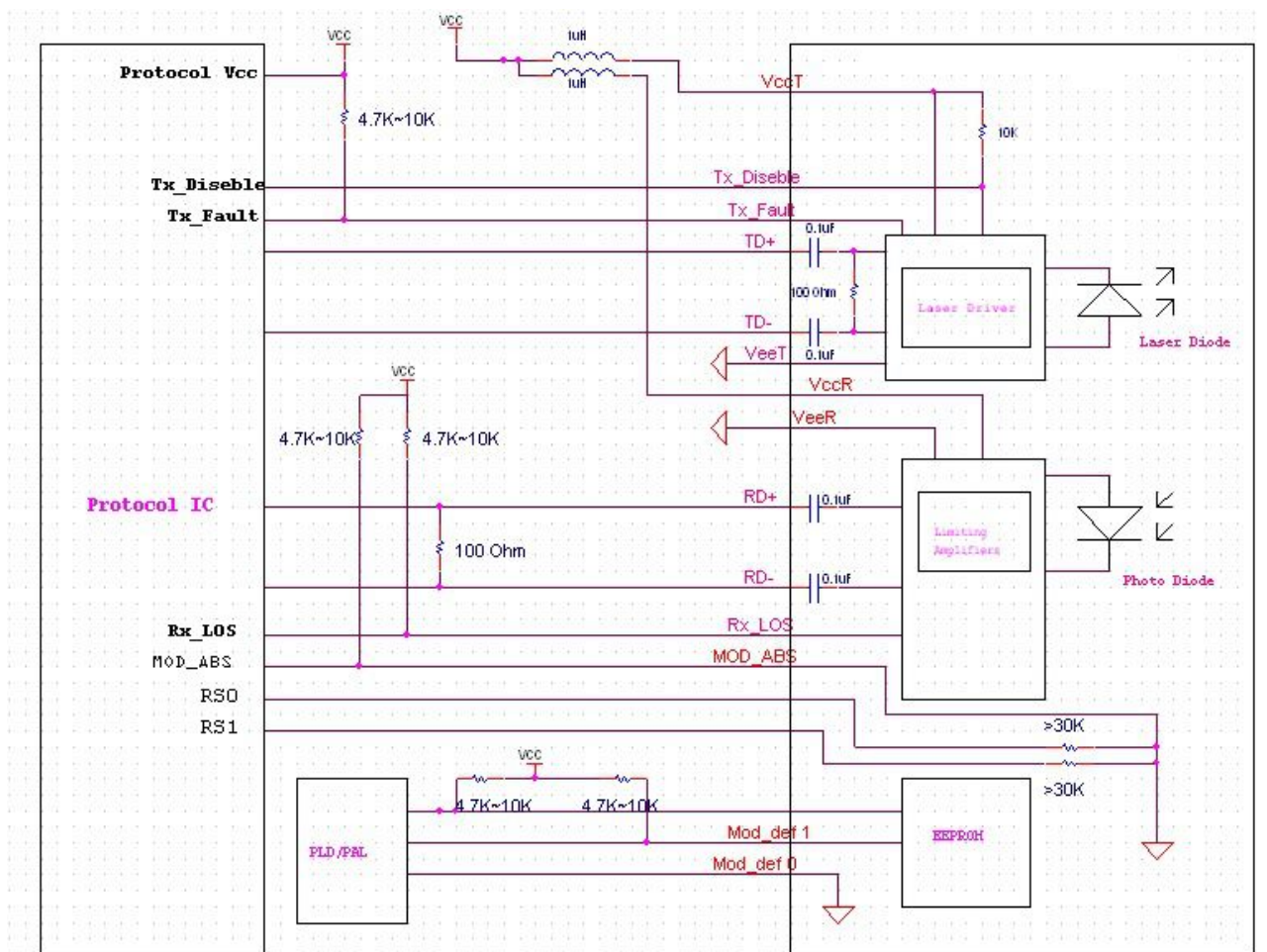

VIII. Outline Dimensions

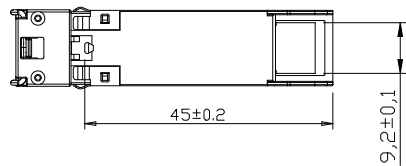
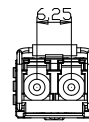
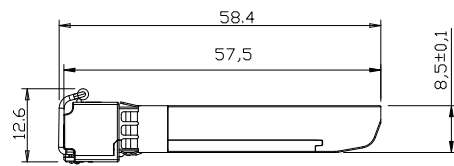
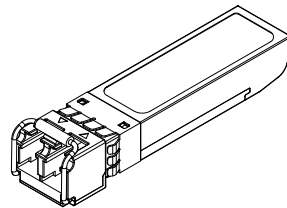
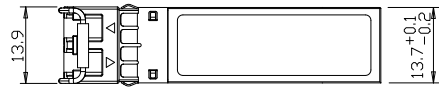

Units in mm

IX. Regulatory Compliance

Feature	Reference	Performance
Electrostatic discharge (ESD)	IEC/EN 61000-4-2	Compatible with standards
Electromagnetic Interference (EMI)	FCC Part 15 Class B EN 55022 Class B (CISPR 22A)	Compatible with standards
Laser Eye Safety	FDA 21CFR 1040.10, 1040.11 IEC/EN 60825-1, 2	Class 1 laser product
Component Recognition	IEC/EN 60950 , UL	Compatible with standards
ROHS	2011/65/EU and (EU)2015/863	Compatible with standards
EMC	EN61000-3	Compatible with standards